

RTMR ORDERING OPTIONS

There are many different ways to order the RTMR block and matching accessories. You can buy individual parts separately so you can 'mix & match' to suit your exact requirements, or you can buy a Prolec RTMR kit that includes many of the parts you need.

1 Select the RTMR Block

20 Fuse Block



10 Fuse / 5 Relay Block



2 Select the mounting & wiring accessories

Pre-Wired Terminals & Jumpers (p.5)



Butt Connectors

Terminals, Cable Seals & Cavity Plugs & Tools (p.4)



Terminal Crimp Tool (p.5)



Bracket Options (p.6)



Terminal Removal Tool (p.5)



OR Alternatively, select one of our RTMR kits.



All Kits Include The RTMR Block, Cover & Brackets.



RTMR Kit With Pre-assembled Cables



RTMR Kit With Loose Terminals & Cable Seals.



Refer page 10 for more information on these products.

3 Select the electrical components



Mini Fuses Regular or Indicating



Fuse Assortment Clamshell Packs



Refer pages 7 & 8 for more information on these products.

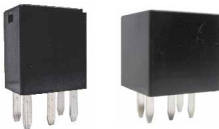

ISO 280 Relays (Micro / Mini) Normally Open SPST (4 pin) Change Over SPDT (5 pin)



Mini Circuit Breakers (Auto, Manual, Modified Reset)



Mini Blade Resistors or Transistors

NEW



ISO 280 Flasher Relays

The Rear Terminal Minifuse and Relay panel (RTMR) is designed to provide efficient power distribution in a rugged compact form, suitable for applications in marine, construction, agriculture, heavy trucking, and specialty vehicle industries.

Components: Accepts Mini fuses, Mini bladed circuit breakers, ISO 280 Mini & Micro relays and ISO 280 Flashers.

All components must have 2.8mm blades on 8.1mm centerline spacing.

Mounting: Threaded inserts # 10-32 as standard (M5 optional).

Block & Cover: Black thermoplastic, improved cover latch design featuring tether. Silicone seal.

Internal Buss: Tin-plated copper (for bussed versions only).

Buss Input Studs: M6 stud bright nickel plated brass (for bussed versions only).

Buss Input Stud Rating: 80A max.

Output Terminal Rating: 30A max per terminal.

Cover Options: Replacement covers also available.

Shallow cover with Gore vent (Mini fuses only) # B151-7168-1-J

Deep cover (Mini fuses / ISO 280 relays / Mini breakers) # B151-7168-2-J

Ingress Protection Rating: IP66-IEC 60529.

(Valid when properly installed with cover, cable seals and cavity plugs).

Wire Size: #22 - #12 AWG / 0.35mm² - 3mm².

Cavity Plugs: Required to fill unused output cavities for ingress protection.

Cable Seals: Please check the overall diameter of your cable before ordering cable seals.

Terminal Tools: Terminal crimping & removal tools page 5.

Pack Size: Stocked lines 1 pc, indent items 20pcs.

Temperature Rating: -40°C to +125°C (PDM only)

Ordering: Block is supplied with tethered cover. Bussed versions also include one nut and one silicone stud cap for each buss input stud.

Not Included: Fuses, circuit breakers, relays, terminals, cable seals, cavity plugs & brackets are optional extras.

Notes: It is possible to use a mixture of Micro and Mini relays in some modules, please refer to page 4.



15303-1-x-x
20 Mini Fuse
Dual Bus



15303-2-x-x
5 Micro Relay
10 Mini Fuse



15303-3-x-x
3 x Mini Relay
10 x Mini Fuse

BLOCK & COVER:

Part Number	Block Layout	Bussing	Included Cover	Nbr of Cavities	Max Nbr of Terminals
15303-1-6-3	20 x Mini fuse (10 components per side).	Bussed both sides	Shallow	20	20
15303-1-6-4	20 x Mini fuse / circuit breaker (10 components per side).	Bussed both sides	Deep	20	20
15303-2-6-4	5 x Micro relay and 10 x Mini fuse / circuit breaker.	Bussed both sides	Deep	35	30
15303-3-6-4	3 x Mini relay / micro relay and 10 x Mini fuse / breaker.	Bussed both sides	Deep	35	22
15303-4-0-4	3 x Mini relay or 5 x micro relay and 10 x Mini fuse / circuit breaker.	No Bussing	Deep	50	45
15303-5-6-4	3 x Mini relay or 5 x micro relay and 10 x Mini fuse / circuit breaker.	Fuse Bussing only	Deep	40	35
15303-6-6-4	3 x Mini relay or 5 x micro relay and 10 x Mini fuse / circuit breaker.	Relay Bussing only *Input stud bussed to pin 86 on relay.	Deep	45	40



Bussing for fuses & relays explained on page 11.
Relay wiring diagrams on pages 12 & 13.
Flashers explained on page 14.

MINIFUSE & ISO 280 RELAY MODULE - SEALED (RTMR) - cont'd

Bussmann

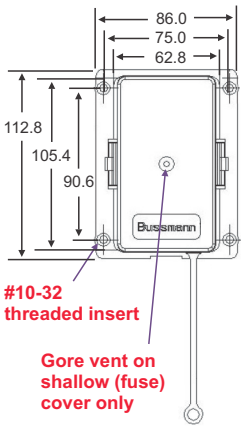

#10-32 threaded insert

Gore vent on shallow (fuse) cover only

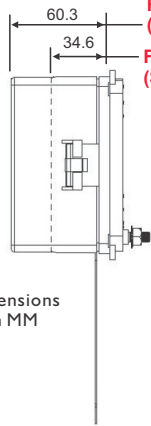

Dimensions in MM

Relay / CB Cover (Deep)
Fuse Cover (Shallow)

⊙ = Stud Input For Busbar

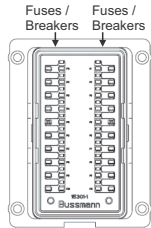

15303-1 Top View

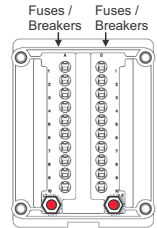

15303-1 Bottom View

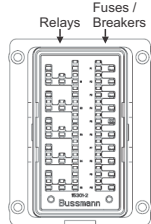

15303-2 Top View

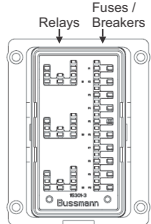

15303-3 Top View

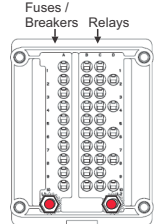

15303-2, 15303-3 Bottom View

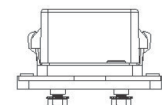

Input studs on bussed versions only.

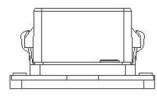

Non-bussed version (have no input studs).

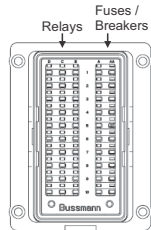

15303-4, 15303-5 Top View

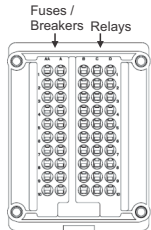

15303-4 Bottom View

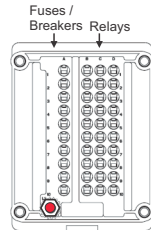

15303-5 Bottom View

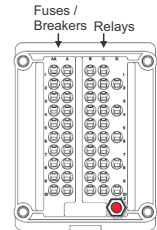

15303-6 Bottom View

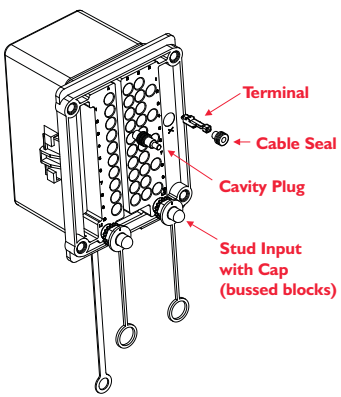

Relay Layout Options:

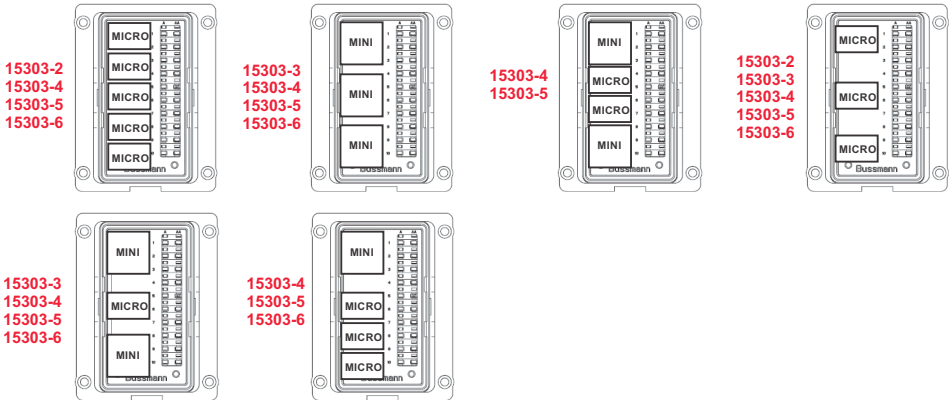

TERMINAL & SEAL KIT

Prolec

Part Number	Description
TERMKIT001	120 piece Assortment Terminal, Seal and Plug Kit Metri-Pack Tangless Female Terminals



NEW

Kit Contents:

TERMINALS: TANGLESS

Female Sealed
Tin Brass / Tin plated



Quantity	Part Number	Wire (AWG)	Wire (mm ²)
10	12110847	#18 - #16	0.80 - 1.0
30	12129409	#16 - #14	1.0 - 2.0
10	12110845	#14 - #12	2.0 - 3.0

CABLE SEALS:

Silicone



Quantity	Part Number	Cable Dia. (mm)	Colour
10	15324982	2.03 - 2.85	Green
30	15324980	2.81 - 3.49	Grey
10	15324981	3.45 - 4.3	Blue

CAVITY PLUG:

Silicone

Quantity	Part Number	Colour
20	12010300	Green



PACKS OF TERMINALS, CABLE SEALS & CAVITY PLUGS

Delphi Metri-Pack 280 Accessories

TERMINALS: TANGLESS

Female sealed
Tin Brass / Tin plated



Part Number	Wire (AWG)	Wire (mm ²)
12110846	#22 - #20	0.35 - 0.50
12110847	#18 - #16	0.80 - 1.0
12129409	#16 - #14	1.0 - 2.0
12110845	#14 - #12	2.0 - 3.0
12110853	#12 - #10	3.0 - 5.0

CABLE SEALS:

Silicone



Part Number	Cable Dia. (mm)	Colour
15324983	1.70 - 1.29	Dark Red
15324982	2.85 - 2.03	Green
15324980	3.49 - 2.81	Grey
15324981	4.30 - 3.45	Blue

CAVITY PLUG:	Part Number	Colour
Silicone	12010300	Green



Terminal Crimp Tool

Part Number	Description
CT-P78	Delphi Metri-Pack 280 & Tyco AMP MCP 2.8 terminals

Need help using this crimp tool?
Scan the QR code to view instructions.



Scan this
QR Code
for more
information



QR Code: 8001

Terminal Removal Tool

Part Number	Description
I2094429	Extracts Delphi Metri-Pack 280 terminals & other types



Search these part numbers
on our website for data sheets.

PRE-ASSEMBLED CABLES & BUTT SPlice CONNECTOR

Packard 280 Metri-Pack Female Sealed Tangless Terminal

Part Number	Description	Colour	Wire Size (mm ²)	Wire Length (mm)	Pack Qty
CAB2.0X300TS1	Output Cable	Red	1.84	305	10
CAB2.0X300TS2	Output Cable	Blue	1.84	305	10
CAB2.0X85TS1J	Jumper Cable	Red	1.84	90	1
I9164-0044	Butt Connector	Blue	1.0 to 2.0	N/A	10



Search these part numbers on our website for datasheets.



MOUNTING BRACKETS & OPTIONAL COVERS

Part Number	Picture	Description
B066-7008	(A)	Red Silicone Stud Cap. Protects Input Studs
PROBRK002	(B)	Low Profile Bracket, Zinc Anneal Powder Coated (1pc Kit) NEW
PROBRK001	(C)	Medium Profile Bracket, Zinc Anneal Powder Coated (1pc Kit) NEW
PROBRK008K	(D)	Tall Profile Brackets, Stainless Steel Natural 1.5mm (2pc Kit)
B151-7168-1-J	(E)	Shallow Cover (Suits Fuses Only & Features A Gore Vent)
B151-7168-2-J	(F)	Tall Cover (Suits Fuses, Circuit Breakers & Relays)

(A) Stud Cap



(B) Low Profile Bracket



Height 31mm

(C) Medium Profile Bracket



Height 45mm

(D) Tall Profile Brackets



Height 56mm



Search these part numbers on our website for data sheets.

Assembled Example (C)

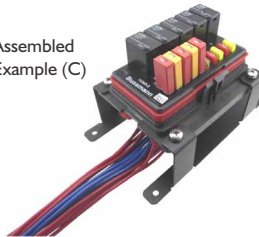

Assembled Example (D)



(E) Shallow Cover With Gore Vent



(F) Tall Cover

(A) Low Bracket Fitted To A Fuse Only RTMR

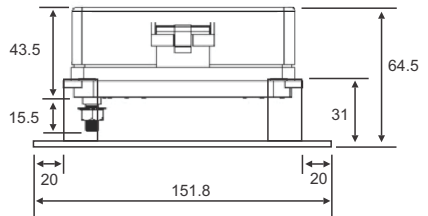

(D) Tall Brackets Fitted To A Fuse & Relay RTMR

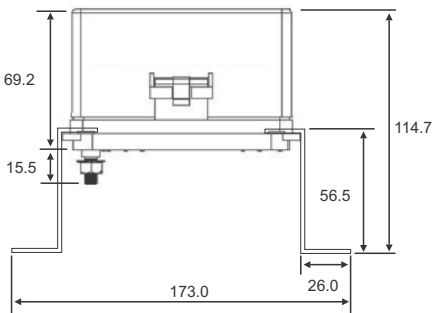

(C) Medium Bracket Fitted To A Fuse & Relay RTMR

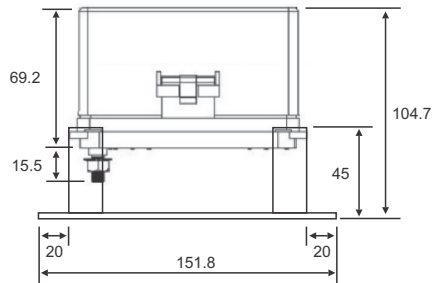

PLUG-IN COMPONENTS

Minifuse 32VDC

Part Number	Ampere Rating
MIN002	2A
MIN003	3A
MIN004	4A
MIN005	5A
MIN07.5	7.5A
MIN010	10A
MIN015	15A
MIN020	20A
MIN025	25A
MIN030	30A



Circuit Breaker (Automatic Reset)

14VDC Automatic TI		Ampere
Part Number	Rating	
21105-00	5A	
21175-00	7.5A	
21110-00	10A	
21115-00	15A	
21120-00	20A	
21125-00	25A	
21130-00	30A	



Minifuse 32VDC (LED Indicating)

Part Number	Ampere Rating
MIND003-32V	3A
MIND005-32V	5A
MIND07.5-32V	7.5A
MIND010-32V	10A
MIND015-32V	15A
MIND020-32V	20A
MIND025-32V	25A
MIND030-32V	30A



Circuit Breaker (Modified Reset)

14VDC Modified TII		Ampere
Part Number	Rating	
21205-00	5A	
21275-00	7.5A	
21210-00	10A	
21215-00	15A	
21220-00	20A	
21225-00	25A	
21230-00	30A	



Minifuse 32VDC Assortment

Part Number	Description
MINI-KIT2	35 Piece Minifuse Assortment Pack

Kit Contains	Quantity
MIN005	5pcs
MIN07.5	5pcs
MIN010	5pcs
MIN015	5pcs
MIN020	5pcs
MIN025	5pcs
MIN030	5pcs



Circuit Breaker (Manual Reset)

28VDC Manual TIII		Ampere
Part Number	Rating	
23305-00	5A	
23375-00	7.5A	
23310-00	10A	
23315-00	15A	
23320-00	20A	
23325-00	25A	
23330-00	30A	



LED Ind. Minifuse 32VDC Assortment

Part Number	Description
MIND-KIT2	16pc LED Ind. Minifuse Assortment Pack

Kit Contains	Quantity
MIND003-32V	2pcs
MIND005-32V	2pcs
MIND07.5-32V	2pcs
MIND010-32V	2pcs
MIND015-32V	2pcs
MIND020-32V	2pcs
MIND025-32V	2pcs
MIND030-32V	2pcs
FP-7AM	1pc



Mini Blade Devices

Part Number	Product
22901-I.5	Transorb
22902-68	Resistor



Search these part numbers on our website for datasheets.

ISO 280 RELAYS, FLASHERS & HAZARD LIGHTS SWITCH

Micro Relays (ISO 280)

Part Number	Description	Contact ratings for resistive load	
		Amp Rating	Protection
3011ACR112	12V Normally Open 4 pin (SPST)	35A (14VDC)	½W 680Ω resistor
3011CCR112	12V Change Over 5 pin (SPDT)	NO:35A / NC:20A (14VDC)	½W 680Ω resistor
3011ACR124	24V Normally Open 4 pin (SPST)	15A (28VDC)	½W 2700Ω resistor
3011CCR124	24V Change Over 5 pin (SPDT)	NO:15A / NC:10A (28VDC)	½W 2700Ω resistor



Search these part numbers on our website for data sheets.

Mini Relays (ISO 280)

Part Number	Description	Contact ratings for resistive load	
		Amp Rating	Protection
898H1AHCRI12	12V Normally Open 4 pin (SPST)	50A (14VDC)	½W 680Ω resistor
898H1CHCRI12	12V Change Over 5 pin (SPDT)	NO:50A / NC:30A (14VDC)	½W 680Ω resistor
898H1AHCRI24	24V Normally Open 4 pin (SPST)	20A (28VDC)	½W 2700Ω resistor
898H1CHCRI24	24V Change Over 5 pin (SPDT)	NO:20A / NC:15A (28VDC)	½W 2700Ω resistor



Flasher Relays (ISO 280)

Part Number	Terminals	Electrical Rating	Nbr. Bulbs / Type
NO-762-LED	2.8mm x 4	12.6A at 12.8VDC	2 to 6 / LED
NO.761	2.8mm x 3	12.6A at 12VDC	2 to 4 / Standard
NO.762	2.8mm x 4	12.6A at 12VDC	3 to 6 / Standard



NO-762-LED

Scan this QR Code for more information



QR Code: 9023



NO.761

Scan this QR Code for more information



QR Code: 9024

Hazard Lights Switch

Part Number	Description	Switching
J2A2UT0BA9C70100	Hazard Switch with Black Hard Nylon Actuator, Square Lens.	On / Off



Rear View

Scan this QR Code for more information



QR Code: 9029

EXTERNAL FUSE PROTECTION

Protect your RTMR fuse block by adding a fuse between the battery and the RTMR input stud.

OPTION 1.

Midfuse Fuse Block

Part Number	Description
MIDFBB	Midfuse block, 32V, 125A max
LMII-E-I-0	Midfuse block, 32V, 200A max stackable



MIDFBB



LMII-E-I-0

(Fuses are not included)

Midfuses

Part Number	Ampere Rating
MID023-32V	23A ^
MID030-32V	30A ^
MID040-32V	40A
MID050-32V	50A
MID060-32V	60A
MID070-32V	70A
MID080-32V	80A
MID100-32V	100A



Element Window Side



Solid Side

Note: When selecting a fuse, please remember that each RTMR input stud is rated at 80A max.

OPTION 2.

Battery Fuse Bars (1 or 2 pole)

Part Number	Description	Stud	Cover
CFBAR1SP-KIT	Single pole kit	1/4"-20	Red
CFBAR1SP-KITB	Single pole kit	1/4"-20	Black
CFBAR1M8SPRK	Single pole kit	M8	Red
CFBAR1M8SPBK	Single pole kit	M8	Black
CFBAR2M8SPRK	Double pole kit	M8	Red
CFBAR2M8SPBK	Double pole kit	M8	Black

Bar Rating: 300A max at 58VDC (or less).

Note: All kits include S/S nuts & washers, cover.



CFBAR1 (Single Pole)



CFBAR2 (Double Pole)



Ring terminal fused protection to RTMR

Battery Fuses

Part Number	Ampere Rating
MRBF030	30A
MRBF040	40A
MRBF050	50A
MRBF060	60A
MRBF075	75A
MRBF080	80A
MRBF090	90A
MRBF100	100A

Rating: 58VDC or less.



Note: When selecting a fuse, please remember that each RTMR input stud is rated at 80A max.



Search these part numbers on our website for data sheets.

RTMR PRE-ASSEMBLED KITS

20 Minifuse Block Kit (with cables)

Part Number
PDMKIT001

Description

This kit can supply fused power for up to 20 output circuits fed by 2 input power leads connected to the rear studs of the block. Each input stud supplies power to 10 circuits (1 side). This kit includes the block & cover, 35 x assorted Minifuses, 20 x pre-terminated cables, 10 x cavity plugs, 20 x butt connectors and 2 x mounting brackets.



20 Minifuse Block Kit (with terminals)

Part Number
PDMKIT004

Description

This kit can supply fused power for up to 20 output circuits fed by 2 input power leads connected to the rear studs of the block. Each input stud supplies power to 10 circuits (1 side). This kit includes the block & cover, 35 x assorted Minifuses, 20 x terminals, 20 x cable seals, 10 x cavity plugs and 2 x mounting brackets.



10 Minifuse/Circuit Breaker & 5 Relay Block Kit (with terminals)

Part Number
PDMKIT002

Description

This block can be fitted with a combination of up to 10 Minifuses or mini-bladed breakers and 5 micro relays (SPDT). There are 2 bussed power studs. One for relays and one for fuses/breakers. This kit includes the block & cover, 30 x terminals, 30 x cable seals, 10 x cavity plugs and 2 x mounting brackets.



10 Minifuse/Circuit Breaker & 5 Relay Block Kit (with cables)

Part Number
PDMKIT003

Description

This block can be fitted with a combination of up to 10 Minifuses or mini-bladed breakers and 5 micro relays (SPDT). There are 2 bussed power studs. One for relays and one for fuses/breakers. This kit includes the block & cover, 30 x pre-terminated cables, 30 x butt connectors, 5 x jumpers, 10 x cavity plugs and 2 x mounting brackets.



Search these part numbers on our website for datasheets.

RTMR INTERNALLY BUSSED UNITS EXPLAINED

Fuse Bussed RTMR Units

The following RTMR units feature an internal fuse bus; 15303-1, 15303-2, 15303-3 & 15303-5. The internal fuse bus feeds power to all 10 fuses from a common input stud on the underside of the block. This reduces the number of terminals, cable seals, cavity plugs and wiring required to assemble the unit. It is also a great time saver. The only negative of using a common power bus is that you cannot power individual fuses from alternate power sources eg. 5 fuses powered directly from battery and 5 fuses powered from ignition power.

RTMR with internal Fuse Bus

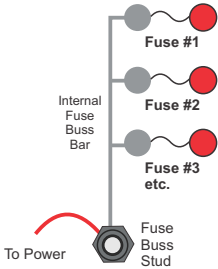

RTMR without internal Fuse Bus

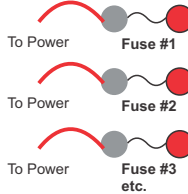

As you can see in these illustrations, the RTMR unit with no internal fuse bus requires an input power cable for every fuse, whereas the RTMR unit with an internal fuse bus only requires 1 power input cable.

Relay Bussed RTMR Units

The following RTMR units feature an internal relay bus; 15303-2, 15303-3 & 15303-6. The internal relay bus provides a common power or ground circuit to relay coil pin 86. There is a common misconception that relay pin 30 (common power) is connected to the relay bus. This is NOT the case. The reason why is that power to relay pin 30 should be supplied from a fuse to ensure that the accessory is fuse protected. So relay pin 30 should be connected to a fuse on the RTMR using a jumper cable.

RTMR with internal Relay Bus

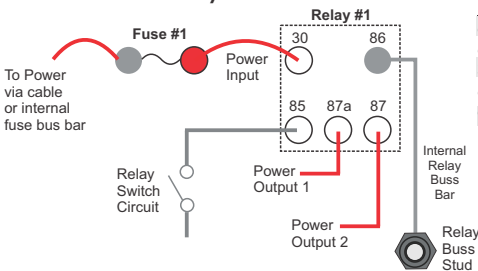

Relay Pin	Description
85	Relay coil power
86	Relay coil power
30	Common power
87	Normally Open
87a	Normally Closed

Relay Circuit Diagram

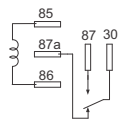

As you can see in the above illustration, relay coil pin 86 is connected to the internal relay bus bar. Relay common pin 30 is connected to a fuse on the RTMR block using a jumper cable. Depending on how you wish to switch the relays, the relay buss stud can be connected to either positive or ground. However, if the relay is diode protected, it can only be used in one wiring configuration. Please refer to pages 12 & 13 which explain these different wiring methods.

Wiring Example 1.

15303-2 (Dual Buss) Fuse/Relay Block with relay coil powered by Relay Buss Stud.

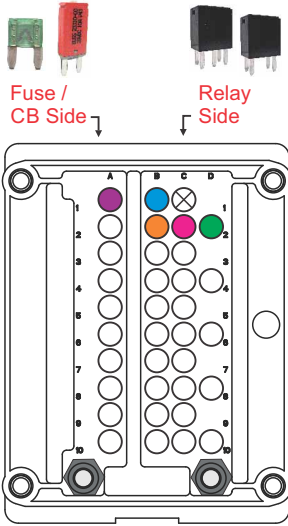

15303-2 (Bottom View)

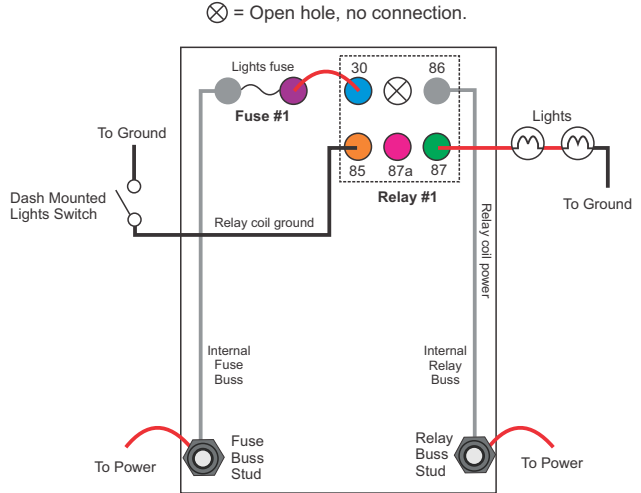

15303-2 Wiring Example (Bottom View).

Suitable Relays for this Circuit:

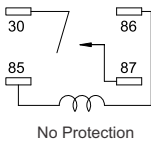

No Protection

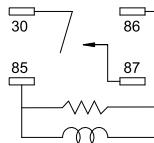

Resistor Protection

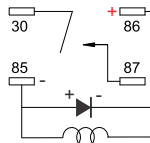

Diode Protection Anode to pin 85

When energizing the coil of a relay, polarity of the coil does not matter unless the relay is diode protected.

When a relay is diode protected, you must connect the positive voltage to the correct terminal of the relay coil as illustrated in the diagram.

Example Overview.

In this simple example we are switching lights on/off using a dash mounted light switch. The circuit is fuse protected (fuse #1) and power to the lights is switched by a normally open relay (relay #1).

How it Works.

When we switch the lights ON at the dash, power flows from the RELAY BUSS STUD into relay coil (pin 86) and out relay coil (pin 85) to GROUND via the lights switch on our dash. Powering the relay coil switches power fed by fuse #1 through a jumper cable to relay pin 30 to flow out relay pin 87 to the lights.

Notes.

Fuses and relays can be wired in any circuit configuration you like. The 15303-2 includes one internal buss for fuses and one internal buss for relays. This buss connects one terminal of each component (fuse / circuit breaker / relay) to the input stud, thereby reducing the amount of wiring that is required for each component.

Wiring Example 2.

15303-2 (Dual Buss) Fuse/Relay Block with relay coil grounded by Relay Buss Stud.

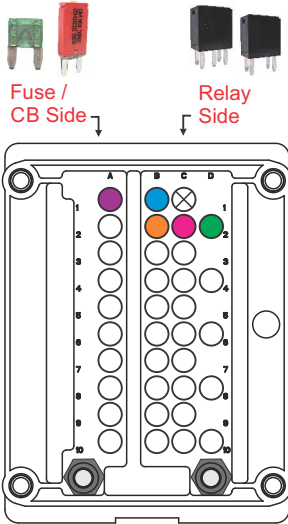

15303-2 (Bottom View)

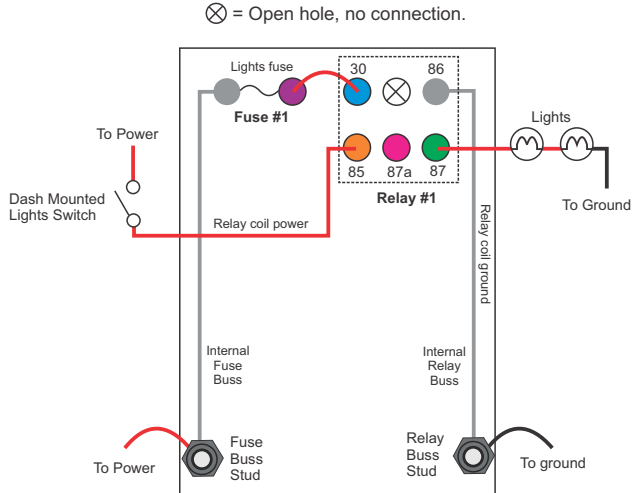

15303-2 Wiring Example (Bottom View).

Suitable Relays for this Circuit:

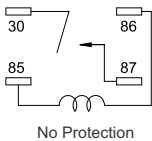

No Protection

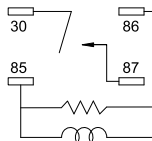

Resistor Protection

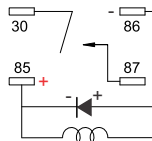

Diode Protection
Anode to pin 86

When energizing the coil of a relay, polarity of the coil does not matter unless the relay is diode protected.

When a relay is diode protected, you must connect the positive voltage to the correct terminal of the relay coil as illustrated in the diagram.

Example Overview.

In this simple example we are switching lights on/off using a dash mounted light switch. The circuit is fuse protected (fuse #1) and power to the lights is switched by a normally open relay (relay #1).

How it Works.

When we switch the lights ON at the dash, power flows from dash mounted lights switch into relay coil (pin 85) and back out relay coil (pin 86) to GROUND via RELAY BUSS STUD. Powering the relay coil switches power fed by fuse #1 through a jumper cable to relay pin 30 to flow out relay pin 87 to the lights.

Notes.

Fuses and relays can be wired in any circuit configuration you like. The 15303-2 includes one internal buss for fuses and one internal buss for relays. This buss connects one terminal of each component (fuse / circuit breaker / relay) to the input stud, thereby reducing the amount of wiring that is required for each component.

Using Flasher Relays in the RTMR.

Flasher relays are typically used to create the on/off flashing effect for turn signals and hazard lights. These relays can easily be installed in the RTMR. Only one flasher relay is required to create both a turn signal & hazard light circuit. There are however, a number of different ways a flasher relay can be wired. Regardless of the method you choose, it is recommended you do NOT use an RTMR that features internal relay bussing. The flasher relay can be installed in 2 different orientations, so please be mindful of this when designing your installation or replacing the relay.

Choosing which RTMR to use for the flasher circuit.

It is recommended you use 2 fuses for your flasher circuit. The first fuse is used to protect the turn signal circuit (which powers the turn signal lights on one side of the vehicle). The second fuse is used to protect the hazard light circuit (which powers the turn signal lights on both sides of the vehicle simultaneously). In most modern vehicles, the hazard lights will operate even if the ignition is OFF, however the turn signals will only operate when the ignition is switched ON. To achieve this functionality, we recommend you use the **15303-4 RTMR** with no internal bussing. However if you do not need this exact functionality, then you can also use the 15303-5 RTMR with internal fuse bussing.

Choosing which flasher to use.

Only flashers that feature ISO280 terminals can be used in the RTMR. We offer a range of flashers to suit the RTMR. When selecting the flasher, you need to consider the following;

1. Is the flasher powering LED turn signal lamps or conventional lamps?
2. Do you prefer a flasher with 3 or 4 terminals?
3. How many lamps will the flasher be operating?

Flasher Relays (LED lamps)



Scan this QR Code for more information



NO-762-LED

QR Code: 9023

Flasher Relays (conventional lamps)



Scan this QR Code for more information



NO.761

QR Code: 9024

Selecting a Hazard Lights Switch.

Selecting a suitable hazard light switch is important, particularly if you wish to power the flasher circuit using 2 different fuses as recommended. The following switch can be wired to 2 different fuses and is suitable for use with both 3 and 4 terminal flashers.



Scan this QR Code for more information



Hazard Lights Switch

QR Code: 9029