

# POWER DIST. MODULE SEALED - 60 POSITION

**IP66**

This unit features 60 open positions with no internal bussing. It is designed for use with 280 style components (i.e. Mini fuses, 280 Relays, diodes, resistors, etc.) and provides efficient power distribution in a rugged compact form with applications in marine, construction, agriculture, heavy trucking, and specialty vehicle industries.

- Output Rating:** 30A max per terminal.
- Terminal Capacity:** 60 terminals on a layout matrix of (6 x 10) suited to 2.8mm blades on 8.1mm centerline spacing.
- Mounting:** Includes threaded inserts # 10-32 as standard (M5 optional).
- Base:** Features letter/number grid front & rear for easy reference of each terminal position. Black thermoplastic with red rubber gasket.
- Cover:** Black thermoplastic. Improved latch design & tether strap.
- Cover Options:** Replacement covers also available. Shallow cover includes Gore vent (Mini fuses only) # B151-7168-1-J. Deep cover (Mini fuses / ISO 280 relays / Mini breakers) # B151-7168-2-J.
- Temperature Rating:** -40°C to +125°C (PDM only).
- Wire Size:** #20 - #12 AWG / 0.5mm<sup>2</sup> - 2.5mm<sup>2</sup>
- Ingress Protection Rating:** IP66 - IEC 529 (valid only when cover, cable seals and cavity plugs are properly fitted).
- Cavity Plugs:** Required to fill unused output cavities for ingress protection.
- Cable Seals:** Please check the overall diameter of your cable before ordering cable seals.
- Terminal Tools:** Terminal crimping tools (see p. 4).
- Not Included:** Terminals, cable seals, cavity plugs, mounting brackets or mounting screws. Module does not include any plug-in components.

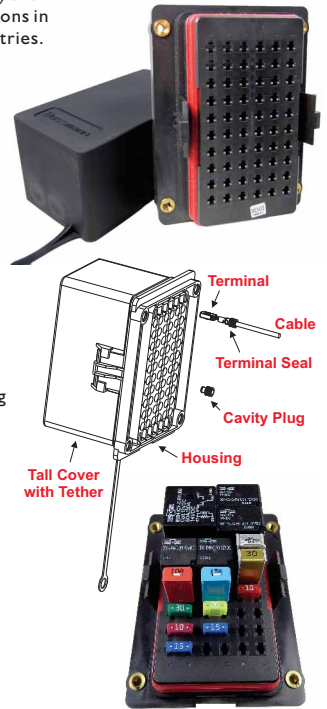

## 60 WAY MODULE & COVER (No Bussing):

Part Number	Block Description	Cover Inc.	Nbr Cavities
I5310-1-1	30 x Mini Fuses Only	Shallow - Fuse	60
I5310-1-2	Mix of 280 Components	Deep - Relay	60

## ACCESSORIES:

Part Number	Description
TERMKIT004	170pc Terminal, Cable Seal & Cavity Plug Assortment Kit.
1-968875-1	Terminal Female MCP 2.8 #20 - #16AWG 0.5 - 1.0mm <sup>2</sup>
1-968876-1	Terminal Female MCP 2.8 #14 - #12AWG 1.5 - 2.5mm <sup>2</sup>
828904-1	Cable Seal Silicone Blue 1.2 - 2.1mm Diameter.
828905-1	Cable Seal Silicone White 2.2 - 3.0mm Diameter.
828922-1	Cavity Plug Silicone Clear
PROBRK008K	Mounting Brackets Stainless Steel Natural (a)
PROBRK001	Mounting Bracket Powder Coated Black (b)

## SURFACE MOUNT BRACKET OPTIONS:



**(a) PROBRK008K**  
2pc Bracket Kit Includes Hardware.

**(b) PROBRK001**  
1pc Bracket Kit Includes Hardware. **NEW**

## RELATED PRODUCTS:



**Fuses, Circuit Breakers etc.**  
Refer page 3.

**Relays & Flashers**  
Refer page 4.

## ACCESSORIES: AMP MCP 2.8

**Terminals:** Female With Locking Barbs  
Copper Nickel / Tin plated

**Cable Seals:** Silicone

**Cavity Plug:** Silicone



**TERMKIT004** (see p.4)



**Mounting Brackets**  
Refer page 5.

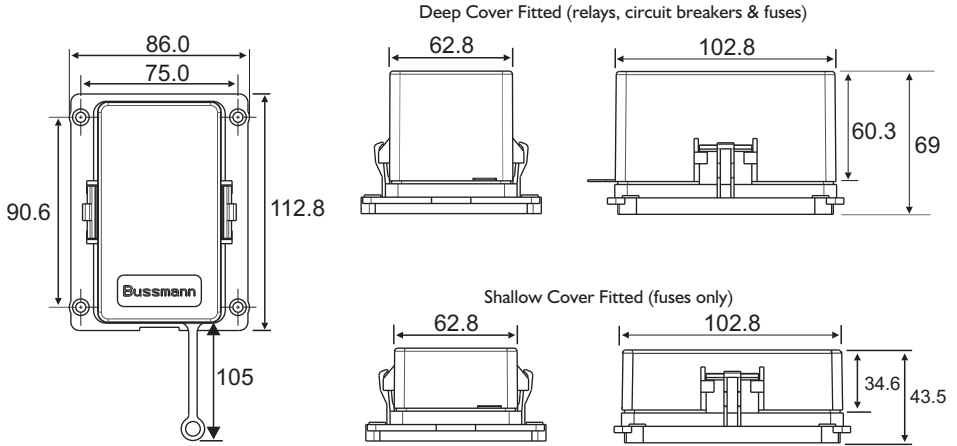

Dimensions are in MM

**Top of Base**

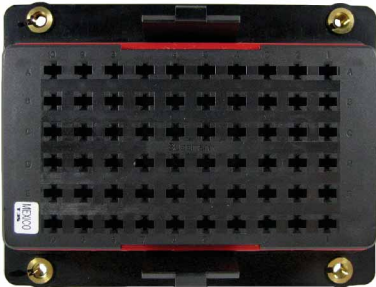

**Underside of Base**



**Cover**



**Minifuse 32VDC**

Part Number	Ampere Rating
MIN002	2A
MIN003	3A
MIN004	4A
MIN005	5A
MIN07.5	7.5A
MIN010	10A
MIN015	15A
MIN020	20A
MIN025	25A
MIN030	30A



**Circuit Breaker (Automatic Reset)**

**14VDC Automatic TI**

Part Number	Ampere Rating
21105-00	5A
21175-00	7.5A
21110-00	10A
21115-00	15A
21120-00	20A
21125-00	25A
21130-00	30A



**Minifuse 32VDC (LED Indicating)**

Part Number	Ampere Rating
MIND003-32V	3A
MIND005-32V	5A
MIND07.5-32V	7.5A
MIND010-32V	10A
MIND015-32V	15A
MIND020-32V	20A
MIND025-32V	25A
MIND030-32V	30A



**Circuit Breaker (Modified Reset)**

**14VDC Modified TII**

Part Number	Ampere Rating
21205-00	5A
21275-00	7.5A
21210-00	10A
21215-00	15A
21220-00	20A
21225-00	25A
21230-00	30A



**Minifuse 32VDC Assortment**

Part Number	Description
MINI-KIT2	35 Piece Minifuse Assortment Pack

Kit Contains	Quantity
MIN005	5pcs
MIN07.5	5pcs
MIN010	5pcs
MIN015	5pcs
MIN020	5pcs
MIN025	5pcs
MIN030	5pcs



**Circuit Breaker (Manual Reset)**

**28VDC Manual TIII**

Part Number	Ampere Rating
23305-00	5A
23375-00	7.5A
23310-00	10A
23315-00	15A
23320-00	20A
23325-00	25A
23330-00	30A



**LED Ind. Minifuse 32VDC Assortment**

Part Number	Description
MIND-KIT2	16pc LED Ind. Minifuse Assort. Pack

Kit Contains	Quantity
MIND003-32V	2pcs
MIND005-32V	2pcs
MIND07.5-32V	2pcs
MIND010-32V	2pcs
MIND015-32V	2pcs
MIND020-32V	2pcs
MIND025-32V	2pcs
MIND030-32V	2pcs
FP-7AM	1pc



**Mini Devices**

Part Number	Product
22901-1.5	Tansorb
22902-68	Resistor



**Mini Diodes**

Part Number	Description
02400104P	Diode Keyed
22903-6	Diode Keyed
22903-6V	Diode Key Wing



 Search these part numbers on our website for datasheets.

# ISO 280 RELAYS & FLASHERS

## Ultra Micro Relays (ISO 280)

Part Number	Description
3031AHCRI12	12V Normally Open 4 pin (SPST)
3031AHCRI24	24V Normally Open 4 pin (SPST)



Search these part numbers on our website for datasheets.

## Micro Relays (ISO 280)

Part Number	Description
3011ACR112	12V Normally Open 4 pin (SPST)
3011ACR124	24V Normally Open 4 pin (SPST)

3011CCR112	12V Change Over 5 pin (SPDT)
3011CCR124	24V Change Over 5 pin (SPDT)



## Mini Relays (ISO 280)

Part Number	Description
898H1AHCRI12	12V Normally Open 4 pin (SPST)
898H1CHCRI12	12V Change Over 5 pin (SPDT)

898H1AHCRI24	24V Normally Open 4 pin (SPST)
898H1CHCRI24	24V Change Over 5 pin (SPDT)



## Flasher Relays (ISO 280)

Part Number	Terminals	Nbr. Bulbs / Type
NO-762-LED	2.8mm x 4	2 to 6 / LED
NO.761	2.8mm x 3	2 to 4 / Standard
NO.762	2.8mm x 4	3 to 6 / Standard



# TERMINAL & SEAL KIT

Prolec

Part Number	Description
TERMKIT004	170 piece Assortment Terminal, Seal and Plug Kit TE AMP MCP 2.8 Tanged Female Sealed Terminals Suits Bussmann # 15310 Series RTMR



NEW

### Kit Contents:

#### TERMINALS: TANGED

Female Sealed  
Copper Nickel / Tin plated



#### CABLE SEALS:

Silicone



Quantity	Part Number	Wire (AWG)	Wire (mm <sup>2</sup> )
30	1-968875-1	#20 - #16	0.50 - 1.0
40	1-968876-1	#16 - #14	1.5 - 2.5

Quantity	Part Number	Cable Dia.(mm)	Colour
30	8289041	1.5 - 2.1	Blue
40	828905-1	2.2 - 3.0	White

#### CAVITY PLUG:

Silicone

Quantity	Part Number	Colour
30	828922-1	Natural



# TERMINAL TOOLS

Prolec

## Terminal Crimp Tool

Part Number	Description
CT-P78	Delphi Metri-Pack 280 & Tyco AMP MCP 2.8 terminals.

Need help using this crimp tool?  
Scan the QR code to view instructions.



Search these part numbers on our website for datasheets.

Scan this QR Code for more information



QR Code: 8001

Datasheet: 9001

**PROLEC**

Email: [info@prolecproducts.com](mailto:info@prolecproducts.com)  
Web: [www.prolecproducts.com](http://www.prolecproducts.com)

Page: 4

# MOUNTING BRACKETS & OPTIONAL COVERS

Part Number	Picture	Description
PROBRK008K	(A)	Tall Mounting Brackets, Stainless Steel Natural (2pc Kit)
PROBRK001	(B)	Medium Profile Mounting Bracket, Zinc Anneal Powder Coated Black (1pc Kit)
PROBRK002	(C)	Low Profile Mounting Bracket, Zinc Anneal Powder Coated Black (1pc Kit)
B151-7168-1-J	(D)	Shallow Cover (Suits Fuses Only & Features A Gore Vent)
B151-7168-2-J	(E)	Tall Cover (Suits Fuses, Circuit Breakers & Relays)

**NEW**  
**NEW**



(A) Tall Brackets



(B) Medium Profile Bracket



(C) Low Profile Bracket

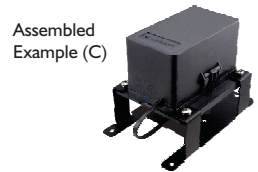
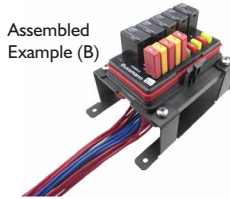
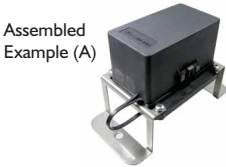

Search these part numbers on our website for datasheets.



(D) Shallow Cover With Gore Vent



(E) Tall Cover

(B) Medium Bracket fitted to a Fuse & Relay RTMR

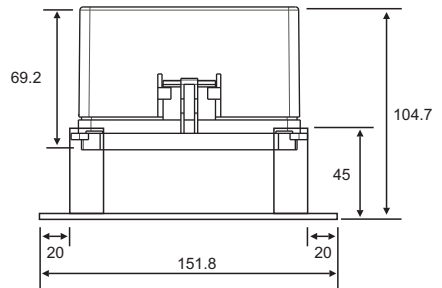

A) Tall Brackets fitted to a Fuse & Relay RTMR

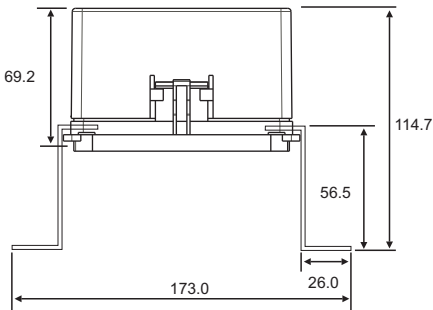

(C) Low Bracket fitted to a Fuse only RTMR

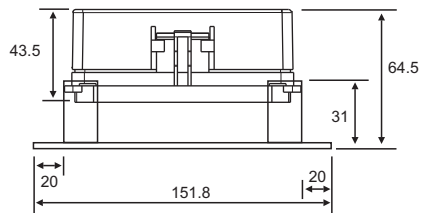

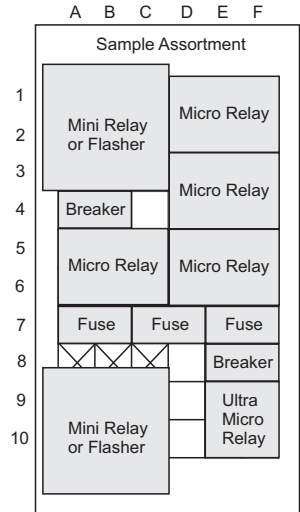
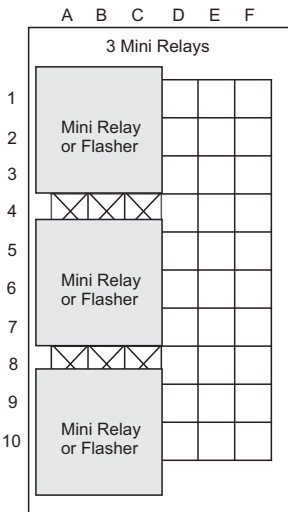
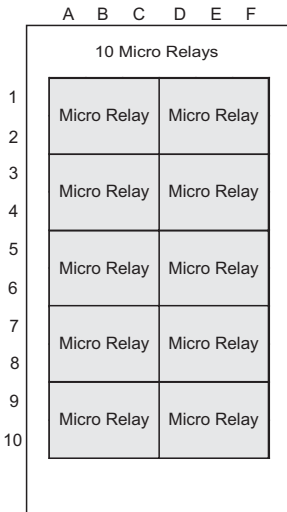
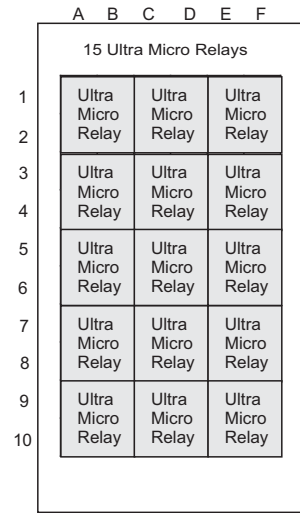
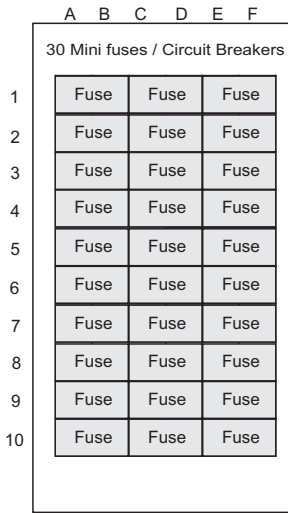
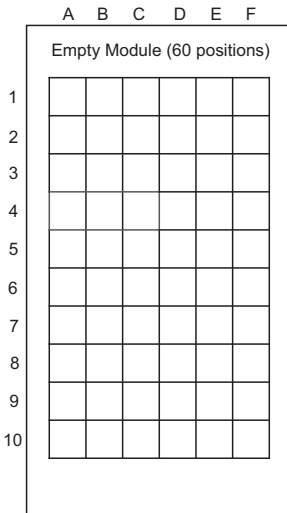

**Component Layout Samples**



**Component information:**

1. Fuses, Breakers, diodes etc. use 2 positions (1x2).
2. Ultra Micro Relays used 4 positions (2x2).
3. Micro Relays use 6 positions (3x2).

-  Unusable position
-  Empty position

**Mini Relays & Flasher Relays:**

1. Cannot be fitted directly beside each other.
2. Maximum of 3 can be fitted.
3. When positioned in top or bottom corners they overlap 9 positions, otherwise they overlap 12 positions.